

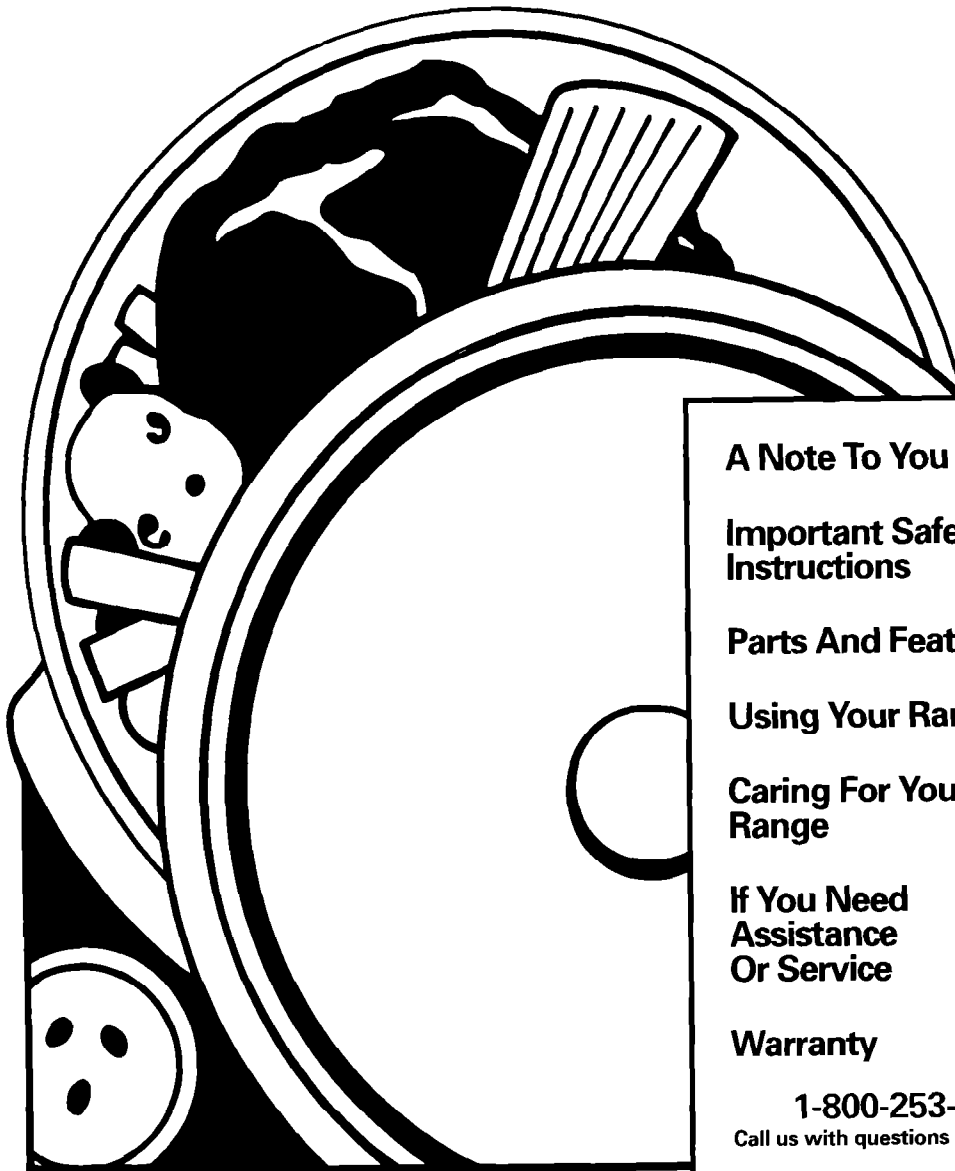

# Use And Care

## G U I D E



A Note To You 2

Important Safety Instructions 3

Parts And Features 6

Using Your Range 7

Caring For Your Range 15

If You Need Assistance Or Service 21

Warranty 24

1-800-253-1301

Call us with questions or comments.

STANDARD-CLEANING GAS RANGES 4-93

TO THE INSTALLER: PLEASE LEAVE THIS INSTRUCTION BOOK WITH THE UNIT.

TO THE CONSUMER: PLEASE READ AND KEEP THIS BOOK FOR FUTURE REFERENCE.

MODELS SF3000SY/EY  
SF304BSA  
SF302BSA/BEA/PSY

# A Note To You

## Thank you for buying a Whirlpool appliance.

You have purchased a quality, *world-class* home appliance. Years of engineering experience have gone into its manufacturing. To ensure that you will enjoy many years of trouble-free operation, we have developed this Use and Care Guide. It is full of valuable information on how to operate and maintain your appliance properly and safely. Please read it carefully. Also, please complete and mail the Ownership Registration Card provided with your appliance. This will help us notify you about any new information on your appliance.

## Your safety is important to us.

This guide contains safety symbols and statements. Please pay special attention to these symbols and follow any instructions given. Here is a brief explanation of the use of each symbol.

### **⚠ WARNING**

This symbol will help alert you to such dangers as personal injury, burns, fire and electrical shock.

### **⚠ CAUTION**

This symbol will help you avoid actions which could cause product damage (scratches, dents, etc.) and damage to your personal property.

	<h3><b>⚠ WARNING</b></h3> <ul style="list-style-type: none"><li>• ALL RANGES CAN TIP.</li><li>• INJURY TO PERSONS COULD RESULT.</li><li>• INSTALL ANTI-TIP DEVICES PACKED WITH RANGE.</li><li>• SEE INSTALLATION INSTRUCTIONS.</li></ul>
--	--

For more information, see the "The anti-tip bracket" on page 15.

## Our Consumer Assistance Center number, 1-800-253-1301, is toll-free, 24 hours a day.

If you ever have a question concerning your appliance's operation, or if you need service, first see "If You Need Assistance Or Service" on page 21. If you need further help, feel free to call our Consumer Assistance Center. When calling, you will need to know your appliance's complete model number and serial number. You can find this information on the model and serial number plate (see diagram on page 6). For your convenience, we have included a handy place below for you to record these numbers, the purchase date from the sales slip and your dealer's name and telephone number. Keep this book and the sales slip together in a safe place for future reference.

Model Number \_\_\_\_\_

Dealer Name \_\_\_\_\_

Serial Number \_\_\_\_\_

Dealer Phone \_\_\_\_\_

Purchase Date \_\_\_\_\_

# Important Safety Instructions

Gas ranges have been thoroughly tested for safe and efficient operation. However, as with any appliance, there are specific installation and safety precautions which must be followed to ensure safe and satisfactory operation.

## **⚠ WARNING**

To reduce the risk of fire, electrical shock, injury to persons, or damage when using the range, follow basic precautions, including the following:

**WARNING: If the information in this manual is not followed exactly, a fire or explosion may result causing property damage, personal injury or death.**

**Do not store or use gasoline or other flammable vapors and liquids in the vicinity of this or any other appliance.**

### **WHAT TO DO IF YOU SMELL GAS:**

- Do not try to light any appliance.
- Do not touch any electrical switch; do not use any phone in your building.
- Immediately call your gas supplier from a neighbor's phone. Follow the gas supplier's instructions.
- If you cannot reach your gas supplier, call the fire department.

**Installation and service must be performed by a qualified installer, service agency or the gas supplier.**

### **General**

- Install or locate the range only in accordance with the provided Installation Instructions. The range must be installed by a qualified installer. The range must be properly connected to the proper gas supply and checked for leaks. The range must also be properly connected to electrical supply and grounded.

- Gas fuels and their use in appliances can cause minor exposures to benzene, formaldehyde, carbon monoxide and soot, primarily from incomplete combustion. Significant exposure to these substances can cause cancer or reproductive harm. Properly adjusted burners with a blue, rather than a yellow, flame will minimize incomplete combustion. Venting with a hood or an open window will further minimize exposure.

continued on next page

# IMPORTANT SAFETY INSTRUCTIONS

- Do not store things children might want above the range. Children could be burned or injured while climbing on it.
- Do not leave children alone or unattended in area where the range is in use. They should never be allowed to sit or stand on any part of the range. They could be burned or injured.
- Do not operate the range if it is damaged or not working properly.
- Do not use the range for warming or heating the room. Persons could be burned or injured, or a fire could start.
- Do not attempt to light the oven burner on electric ignition models during a power failure. Personal injury could result. Reset oven controls to the off position in the event of a power failure.
- Use the range only for its intended use as described in this manual.



- **DO NOT TOUCH SURFACE BURNERS, AREAS NEAR SURFACE BURNERS OR INTERIOR SURFACES OF OVEN.**  
Areas near surface burners and interior surfaces of an oven become hot enough to cause burns. During and after use, do not touch, or let clothing or other flammable materials contact surface burners, areas near surface burners or interior surfaces of oven until they have had sufficient time to cool. Other surfaces of the range may become hot enough to cause burns; such as, the oven vent opening, the surface near the vent opening, the cooktop and the oven door.



- Do not wear loose or hanging garments when using the range. They could ignite if they touch a hot surface burner and you could be burned.
- Use only dry potholders. Moist or damp potholders on surface burners may result in burns from steam. Do not let potholder touch surface burners. Do not use a towel or bulky cloth for a potholder. It could catch on fire.
- Keep range vents unobstructed.
- Do not heat unopened containers. They could explode. The hot contents could cause burns and container particles could cause injury.
- Do not store flammable materials on or near the range. The fumes can create an explosion and/or fire hazard.
- Do not use the oven for storage.
- Never use a match or other flame to look for a gas leak. Explosion and injury could result.
- Know where your main gas shutoff valve is located.

## **When using the cooktop**

- Make sure the utensils you use are large enough to contain food and avoid boilovers and spillovers. Heavy splattering or spillovers left on a range can ignite and burn you. Pan size is especially important in deep fat frying.
- Check to be sure glass cooking utensils are safe for use on the range. Only certain types of glass, glass-ceramic, ceramic, earthenware or other glazed utensils are suitable for cooktops without breaking due to the sudden change in temperature.

## IMPORTANT SAFETY INSTRUCTIONS

- Never leave surface burners unattended at high heat settings. A boilover could result and cause smoking and greasy spillovers that may ignite.



- Turn pan handles inward, but not over other surface burners. This will help reduce the chance of burns, igniting of flammable materials, and spills due to bumping of the pan.
- Do not use decorative covers or trivets over the surface burners.

### When using the oven

- Always position the oven rack(s) in desired location while oven is cool.
- Use care when opening oven door. Let hot air or steam escape before removing or replacing food.

### Grease

- Grease is flammable. Do not allow grease to collect around cooktop or in vents. Wipe spillovers immediately.



- Do not use water on grease fires. Never pick up a flaming pan. Smother flaming pan by covering with a well-fitted lid, cookie sheet or flat tray. Flaming grease outside of pan can be extinguished with baking soda or, if available, a multipurpose dry chemical or foam-type extinguisher.

### Care and cleaning

- Do not clean door heat seal. It is essential for a good seal. Care should be taken not to rub, damage or move the seal. Clean only parts recommended in this Use and Care Guide.
- Do not repair or replace any part of the range unless specifically recommended in this manual. All other servicing should be referred to a qualified technician.
- On some models, disconnect the electrical supply before servicing the range. On all models, disconnect the gas supply at the shutoff valve near the range before servicing.

– SAVE THESE INSTRUCTIONS –

# Parts And Features

This section contains captioned illustrations of your range. Use them to become familiar with the location and appearance of all parts and features.

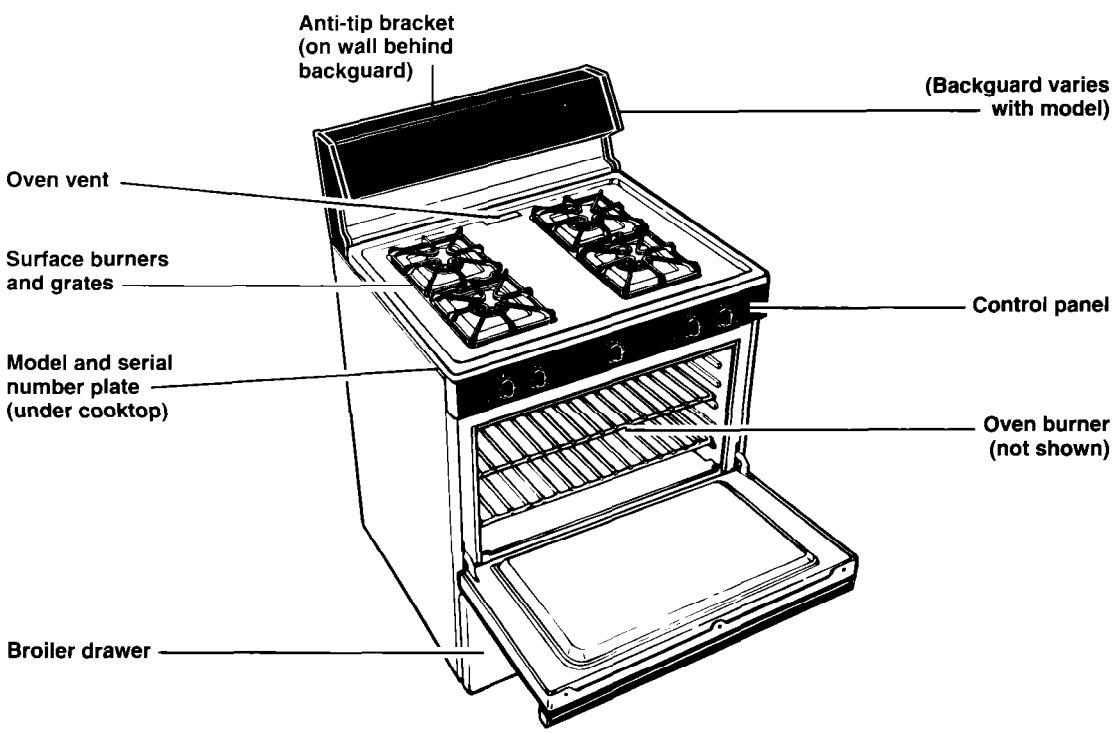

## Control panel

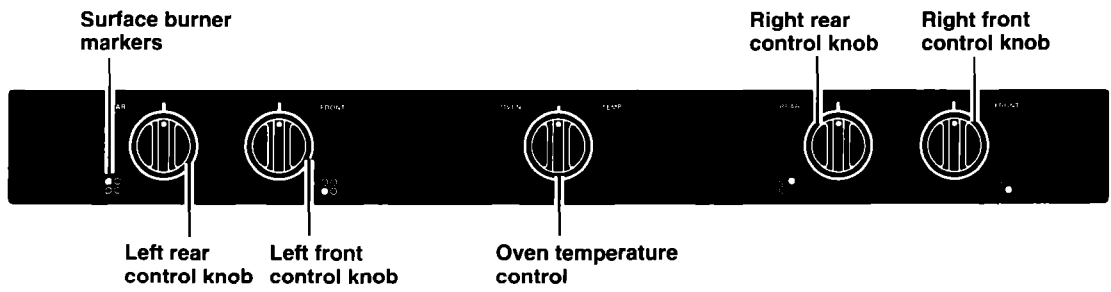

# Using Your Range

In This Section		Page	Page
Using the surface burners .....	7	Adjusting the oven temperature control .....	13
Positioning racks and pans .....	9	Broiling .....	13
For best air circulation .....	10	Energy saving tips .....	14
Lighting standing pilots .....	11	The oven vent .....	14
Baking/roasting .....	12	The anti-tip bracket .....	15

To obtain the best cooking results possible, you must operate your range properly. This section gives you important information for efficient and safe use of your range.

## Using the surface burners

Your range is equipped with either standing pilots or electric ignitors. Standing pilots must be lit initially with a match following the directions on page 11. The pilot light will remain lit when the burners are turned off. To turn a burner on again, just **push in** and **turn** the control knob to LITE and the burner will light. Electric ignitors automatically light the burners each time the control knob is turned to LITE.

**Push in control knobs** and **turn** them to the LITE position. On electric ignitor models, the clicking sound is the ignitor sparking. **Visually check that burner has lit.**

**After the burner lights, turn** the control knob to the desired setting. You can set the control knob anywhere between HI and LO.

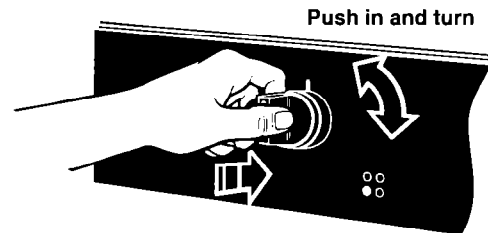

### Surface burner markers

The solid dot in the surface burner marker shows which surface burner is turned on by that knob.

### Burner heat settings

**Use** correct burner heat settings (see next page). If the heat setting is too high, it can:

- **Char** bacon and cause curling.
- **Make** eggs tough and crisp at the edges.
- **Toughen** liver, fish and seafood.
- **Scorch** delicate sauces and custards.
- **Cause** a boilover.

## USING YOUR RANGE

Until you get used to the settings, use the following as a guide. For best results, start cooking at the high setting; then turn the control knob down to continue cooking.

SETTING	RECOMMENDED USE
LITE	<ul style="list-style-type: none"><li>• To light the burner. After the burner lights, turn control back to a desired setting.</li></ul>
HI	<ul style="list-style-type: none"><li>• To start foods cooking.</li><li>• To bring liquids to a boil.</li></ul>
Medium	<ul style="list-style-type: none"><li>• To hold a rapid boil.</li><li>• To fry chicken or pancakes.</li><li>• For gravy, pudding and icing.</li><li>• To cook large amounts of vegetables.</li></ul>
LO	<ul style="list-style-type: none"><li>• To keep food warm until ready to serve.</li></ul>

**NOTE:** Do not cook with the control in the LITE position.

### In case of a prolonged power failure

Surface burners with electric ignitors can be manually lighted. Hold a lit match near a burner and slowly turn the control knob on until the burner lights. After the burner lights, turn the control knob to the desired setting. Power failures will not affect standing pilots. Do not attempt to operate an electric ignition oven during a power failure.

### **⚠ WARNING**

#### **Burn, Fire, Explosion and Product Damage Hazard**

- Burner flame should not extend beyond the edge of the cooking utensil. The flame can burn you and cause poor cooking results.
- Be sure all control knobs are turned to OFF when you are not cooking. Someone could be burned or a fire could start if a burner is accidentally left ON.
- If the flame should go out while cooking, or if there is a strong gas odor, turn the burners OFF. Wait five minutes for the gas odor to disappear before relighting burner. If gas odor is still present, see safety note on page 3. Failure to follow these precautions could result in explosion or fire.
- Do not leave an empty utensil, or one which has boiled dry, on a hot surface burner. The utensil can overheat and may damage the utensil or cooking product.

### Cookware tips

There is no one brand of cooking utensil that is best for all people. Knowing something about pan materials and construction will help you select the correct cooking utensils for your needs.

- **NOTE: For best results and greater fuel efficiency,** use only flat-bottomed utensils that make good contact with the surface burners. Utensils with rounded, warped, ridged (porcelain enamel-ware) or dented bottoms could cause severe overheating, which damages the utensil and/or surface burner.

Woks, canners and teakettles with flat bottoms suitable for use on your cooktop are now available in most stores that sell housewares.

- **The pan** should have straight sides and a tight-fitting lid.
- **Choose medium to heavy gauge** (thickness) pans that are fairly lightweight.
- **The pan material** (metal or glass) affects how fast heat transfers from the surface burners through the pan material and how evenly heat spreads over the pan bottom. Choose pans that provide the best cooking results.
- **Handles** should be made of a sturdy, heat-resistant material and be securely attached to the pan.
- **Pans** should be easy to clean. Check to be sure there are no crevices, rough edges or areas where food might collect.
- **Be sure pans** do not tip, whether they are full or empty.
- **Use utensils** only as they were intended to be used. Follow pan instructions. This is very important for glass cookware because some should be used only in the oven. Other pans are marked as flameware and may be used on the surface burners.



**Home canning information**

The larger diameter of most water-bath or pressure canners combined with high heat settings for long periods of time can cause damage to the cooktop.

**To protect your range:**

- **For best results**, use a canner which can be centered over the surface burner.
- **Do not place canner** on two surface burners at the same time. Too much heat will build up and will damage the cooktop.
- **Start with hot water**. This reduces the time the control is set on high. Reduce heat setting to lowest position needed to keep water boiling.

**Positioning racks and pans**

For baking/roasting with one rack, place the rack so the top of the food will be centered in the oven.

**Rack placement for specific foods:**

FOOD	RACK POSITION
Frozen pies, large roasts, turkeys	1st or 2nd rack guide from bottom
Angel and bundt cakes, most quick breads, yeast breads, casseroles, meats	2nd rack guide from bottom
Cookies, biscuits, muffins, cakes, nonfrozen pies	2nd or 3rd rack guide from bottom

When baking on two racks, arrange racks on first and third rack guides from bottom.

**6th oven rack position (roasting rack)**

When roasting food too large to be placed in oven with rack in lowest position, **place** rack on bottom of oven.

**For proper roasting, follow these guidelines:**

- **The rack** must be level.
- **Use** adequate amount of liquid (meat juices or water) so food does not get overdone.
- **Do not try to pull** rack out over door. Rack will be at the same level as door when door is opened.

**⚠ WARNING**

**Personal Injury Hazard**

- Always position oven rack(s) in desired location before turning oven on. Be sure the rack(s) is level.
- If rack(s) must be moved while oven is hot, use potholders or oven mitts to protect hands.
- Do not place items on the open oven door.
- Be careful when installing and removing large food items from sixth rack position. Food will be close to hot surfaces, including oven bottom and sides.

Failure to follow the above precautions may result in personal injury.

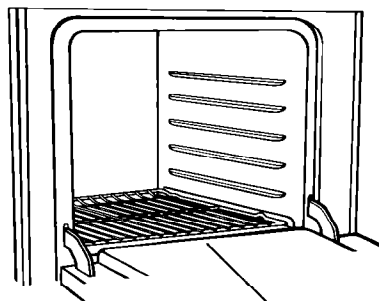

6th oven rack position

### For best air circulation

Hot air must circulate around the pans in the oven for even heat to reach all parts of the oven. This results in better baking.

- **Place** the pans so that one is not directly over the other.
- **For best results, allow** 1½-2 inches (4-5 cm) of space around each pan and between pans and oven walls. There must be a minimum space of 1 inch (2.5 cm).
- **Use** only one cookie sheet in the oven at one time.

Use the following as a guide to determine where to place the pans.

#### **One pan**

Place in the center of the oven rack.

#### **Two pans**

Place in opposite corners of the oven rack.

#### **Three or four pans**

Place in opposite corners on each oven rack. Stagger pans so no pan is directly over another.

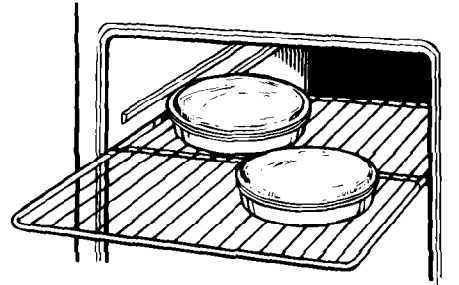

## Lighting standing pilots

(models SF3000SY, SF304BSA, SF302BSA and SF302PSY)

### To light range pilots:

1. **Make sure** all controls are turned off.
2. **Remove** the surface burner grates from the cooktop. **Lift** the cooktop. (See "Lift-up cooktop" on page 16.)

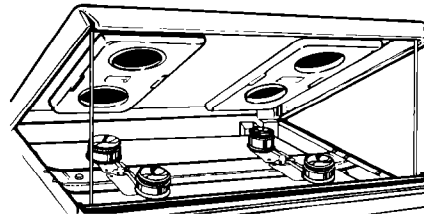

3. **To light, hold** a lit match over the pilot light located between the front and back burners. The pilot flame should be  $\frac{1}{4}$  to  $\frac{3}{8}$  in (.6-1 cm) high.

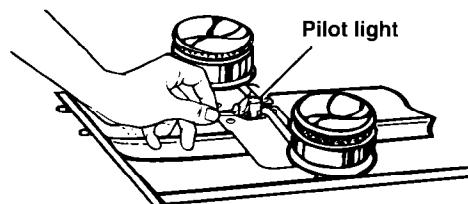

4. **If the pilot flame needs adjustment, turn** the pilot adjustment screw midway down the length of the manifold pipe, behind the control panel.
5. **Lower** the cooktop and **replace** the grates before using the surface burners.

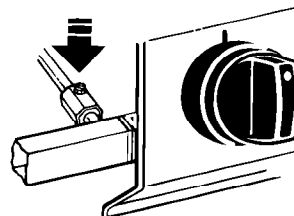

### To light oven burner pilot:

1. **Make sure** the Oven Temperature Control is turned off.
2. **Remove** the oven bottom (see "Removing the oven bottom" on page 18). Then **unscrew** the burner baffle located on the burner (see Installation Instructions for more information about the baffle).
3. **Hold** a lit match over the oven burner pilot located at the rear of the burner.
4. **After the oven burner pilot is burning steadily, check** burner lighting by turning the Oven Temperature Control to a temperature above 140°F (60°C). The burner will take 50-60 seconds to light.
5. **Replace** the burner baffle and oven bottom.

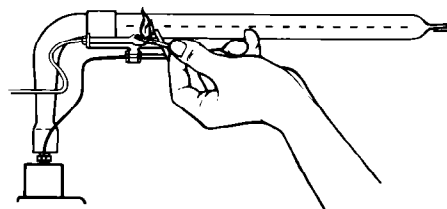

## Baking/roasting

1. **Position** the rack(s) properly **before** turning on the oven. **To change rack position, lift** rack at front and **pull out**. For further information, **see** "Positioning racks and pans" on page 9.
2. **Push in and turn** the Oven Temperature Control to the baking/roasting temperature you want. The oven burner will automatically light in 50-60 seconds.
3. **When baking, preheat** the oven for 10 minutes. **Put** food in the oven.  
**NOTE:** Do not preheat when roasting or cooking items such as casseroles.  
Do not place food directly on the oven bottom.
4. During baking/roasting, the oven burner will turn on and off to maintain the temperature setting.

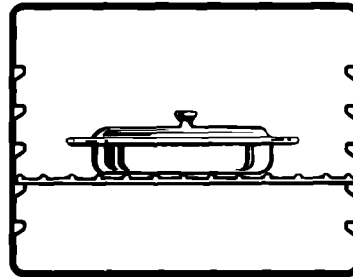
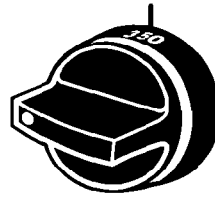

5. **When baking/roasting is done, turn** the Oven Temperature Control to OFF.

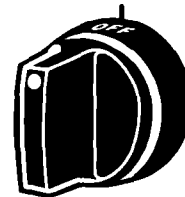

## Adjusting the oven temperature control

Oven temperature controls will gradually shift after years of use. So, even though your new oven is properly adjusted to provide accurate temperatures, it may cook faster or slower than your old oven.

If, after using the oven for a period of time, you are not satisfied with the temperature settings, you can adjust them by following these steps:

1. **Push in and turn** the Oven Temperature Control Knob to the off position. **Pull** knob straight off and **flip** it over.

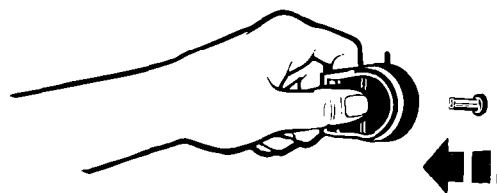

2. **Loosen** the locking screws inside the control knob. **Note the position of the notches.**
3. **To lower the temperature, hold** knob handle firmly and **move** the tooth a notch clockwise. Each notch equals about 10°F (5°C).
4. **To raise the temperature, hold** knob handle firmly and **move** the tooth a notch counterclockwise. Each notch equals about 10°F (5°C).

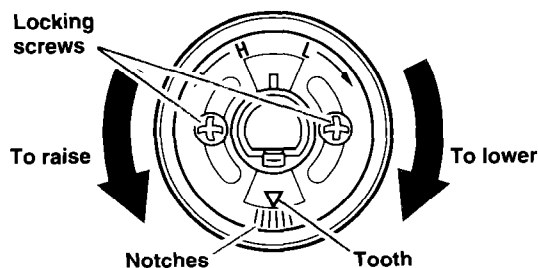

**Tighten the locking screws and replace the control knob.**

## Broiling

The broiler drawer is located below the oven door. **Always broil with the oven door closed.**

1. **Pull** the broiler drawer open and **tilt** the door panel down.

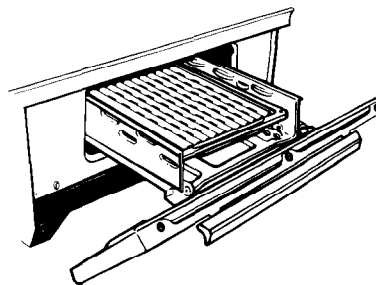

2. **Place** broiler pan grid so grease can drain down ribbing and through slots into lower part of the broiler pan. **See** picture.
3. **Before the broiler is turned on, place** food on broiler pan and **position** the broiler pan at one of the three levels. **Refer** to a reliable cookbook for broiling chart.

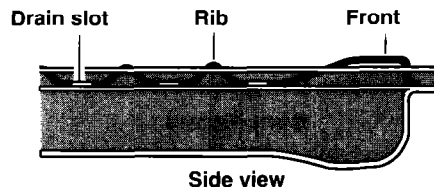

## USING YOUR RANGE

4. **Push in and turn** the Oven Temperature Control to BROIL. The broiler will automatically light in 50-60 seconds.

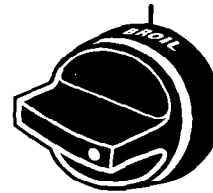

5. **When broiling is done, turn** the Oven Temperature Control to OFF.

**NOTE:** Do not preheat the broiler before using. Completely close the broiler drawer during broiling.

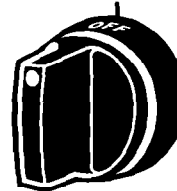

## Energy saving tips

Although the energy used for cooking is usually a very small percentage of the total energy used in the home, cooking energy can be used efficiently. Here are some tips to help you save energy when using your cooking product.

- **Use** pans with flat bottoms, straight sides and tight-fitting lids.
- **Cook** with a minimum of liquid or fat to help shorten cooking time.
- **Preheat** pans only when recommended and for the shortest time possible.
- **Start** food on higher heat settings, then set surface burner control on low or off to finish cooking. Use retained heat for cooking when possible.
- **Use** the more efficient surface burners instead of the oven when possible.
- **Turn on** the surface burner only after placing filled pan on the burner grate.
- **“Oven peeking”** may cause heat loss, longer cooking times and unsatisfactory baking results. Rely on your timer to keep track of the cooking time.
- **Bake** cakes, pies or cookies when oven is warm. Best time is after a meal has been cooked in it.
- **Preheat** the oven no longer than necessary.
- **Plan** your meals for the most efficient use of the range. When using the oven to cook one food, try to cook the rest of the meal in it also.
- **Do not preheat** when broiling, roasting or cooking items such as casseroles.

## The oven vent

Hot air and moisture escape from the oven through a vent located under the backguard. The vent is needed for air circulation. **Do not block the vent.** Poor baking/roasting will result.

**NOTE:** Never store plastics, paper or other items that could melt or burn near the oven vent, or any of the surface burners.

Oven vent

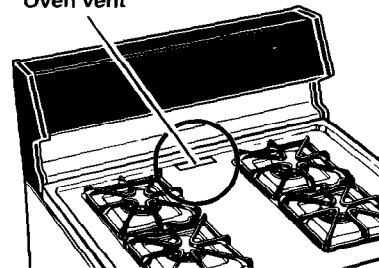

### ⚠ WARNING

#### Burn Hazard

When the oven is ON, pans and pan handles left near the oven vent can become hot enough to burn the user and to melt plastics. Use potholders to move pans.

## The anti-tip bracket

The range will not tip during normal use. However, tipping can occur if you apply too much force or weight to the open door without the anti-tip bracket properly secured.

**To verify the anti-tip bracket is engaged:**

- **Look** to see if the anti-tip bracket is attached with screws to the wall behind the backguard.
- **Make sure** the cable tether on the back of the range is secured by the two hooks on the bracket.
- **See** Installation Instructions for further details.

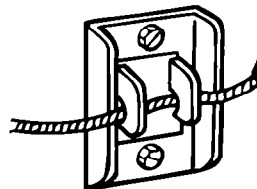

# Caring For Your Range

## In This Section

	Page		Page
Surface burner grates .....	15	Removing the oven door .....	17
Lift-up cooktop .....	16	Removing the oven bottom .....	18
Surface burners .....	16	Cleaning chart .....	19

Your range is designed for ease of care. You can do most cleaning with items found around your home. Cleaning your range whenever spills or soiling occurs will help to keep it looking and operating like new.

## ⚠ WARNING

### Burn, Electrical Shock, Fire and Explosion Hazard

- Make sure all controls are OFF and the range is cool before cleaning.
- Do not use oven cleaners, bleach or rust removers.
- Do not obstruct the flow of combustion and ventilation air.

Failure to follow these guidelines could result in burns, electrical shock, fire or explosion.

## Surface burner grates

1. **Make sure** all surface burners are off and the surrounding parts are cool.
2. **Lift off** the surface burner grates.
3. **Wash** the grates with warm, soapy water or in a dishwasher. **Use** a nonabrasive, plastic scrubbing pad for cooked-on foods. **Rinse** and **dry** well.
4. **Replace** burner grates.

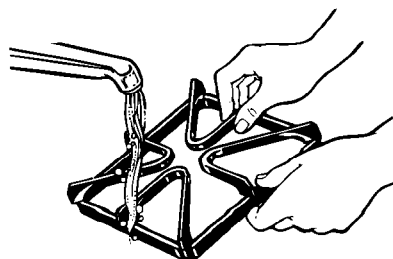

## Lift-up cooktop

1. **Remove** surface burner grates.
2. **Lift** front of cooktop at both front corners until the support rods lock into place.

### ⚠ WARNING

#### Personal Injury and Product Damage Hazard

- Be sure both support rods are fully extended and in the locked position. Failure to do so could result in personal injury from the cooktop accidentally falling.
- Do not drop the cooktop. Damage can result to the porcelain and the cooktop frame.

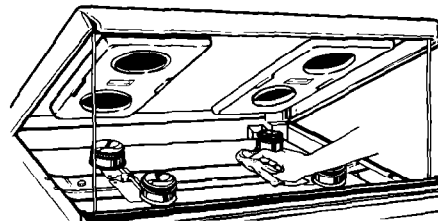

3. **Wipe** with warm, soapy water. **Use** a soapy steel-wool pad on heavily soiled areas.  
NOTE: When cleaning under the cooktop on standing pilot models, be careful not to extinguish pilots.
4. **To lower the cooktop, lift** cooktop from both sides while pressing the support rods back to unlock them. **Lower** the cooktop into place. **Replace** surface burner grates.

## Surface burners

1. **Lift up** the cooktop, following the instructions above.
2. **Before cleaning, remove** screws that hold each of the burners in place. The screws prevent the burners from moving during shipment. **Remove** the shipping screws with a Phillips screwdriver, **lift** the burner up, **tilt** it to one side at the end closest to the ignitor and **move** it toward the back of the range. This separates the burner from the gas valve at the front of the range, so it can be easily removed.
3. **Wipe off** surface burners with warm, soapy water and a sponge after each use. **To remove cooked-on food, soak** the burners in a vinegar and water solution for 20-30 minutes. Scrub with a plastic scrubbing pad.
4. **If ports are clogged, clean with a straight pin. DO NOT enlarge or distort the ports. DO NOT use a toothpick to clean the ports.**

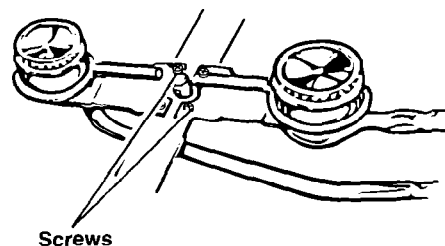



5. **Before putting the burners back, dry** them thoroughly by setting them in a warm oven for 30 minutes.
6. **Replace** burners, making sure they are properly seated and level. **Replace** screws.
7. **Occasionally check** the burner flames for proper size and shape as shown. A good flame is blue in color. If flames lift off ports, are yellow, or are noisy when turned off, you may need to clean the burners (see page 16), or call a qualified technician for adjustment.

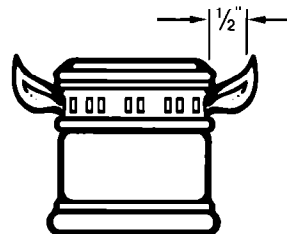

Typical surface burner flame  
at the highest setting

---

## Removing the oven door

Removing the oven door will help make it easier to clean the oven.

### **⚠ WARNING**

#### **Burn and Electrical Shock Hazard**

Make sure all controls are OFF and the oven is cool before removing oven door. Failure to do so can result in burns or electrical shock.

#### **To remove:**

1. **Open** the door as far as it will go.
2. **Remove** the screws on each side of the oven door.
3. **Close** the door about  $\frac{3}{4}$  of the way.
4. **Lift** the door up and off the hinges.

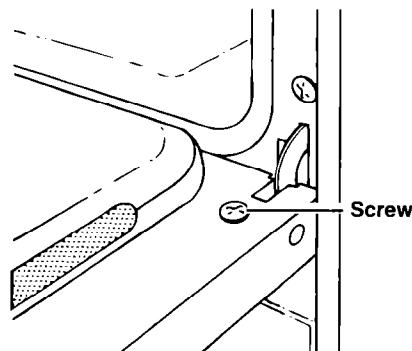

## CARING FOR YOUR RANGE

### To replace:

1. **Be sure** the hinge arms are in the open position. **Be careful** if pulling the hinges open by hand. Hinges may snap back against the oven frame and could pinch fingers.
2. **Hold** the door at the sides near the top. **Insert** hinge arms into slots at the bottom of the door. **Insert** arms evenly, as far as they will go.
3. If the door is not in line with the oven frame, **remove** it and **repeat** the above steps.
4. **Replace** the screws on the oven door.

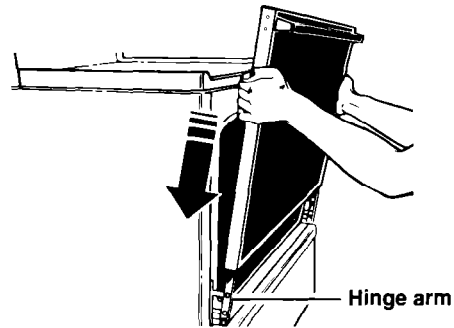

## Removing the oven bottom

The panel in the oven bottom can be removed for cleaning or to light the burner pilot.

### To remove:

1. **Remove** oven racks.
2. **Remove** the two hold-down screws at the rear of the oven. If screws are too tight to remove by hand, **use** a screwdriver.

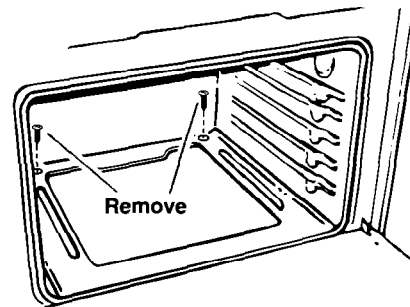

3. **Place** fingers in slots in bottom panel and **lift** rear of panel up and back until lip at the front of panel is clear of front frame of oven cavity.
4. **Lift** bottom up and out.

### To replace:

1. **Place** oven bottom panel in oven with the back raised about 6 inches or until you can insert the hold-down lip at front of panel under the front frame of oven cavity.
2. **Push** back of oven bottom panel down fully into place on metal flanges on rear wall and **insert** the hold-down screws.

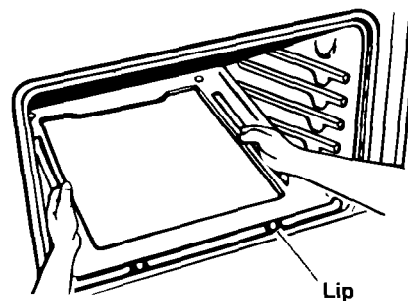

## Cleaning chart

Use the following table to help you clean all parts of your range.

PART	WHAT TO USE	HOW TO CLEAN
<b>Control knobs</b>	Sponge and warm, soapy water	<ul style="list-style-type: none"> <li>• Turn knobs to OFF and pull straight away from control panel.</li> <li>• Wash, rinse and dry thoroughly. Do not soak.</li> <li>• Replace knobs. Make sure all knobs point to OFF.</li> </ul> <p>DO NOT USE steel wool or abrasive cleaners. They may damage the finish of the knobs.</p>
<b>Control panel</b>	Sponge and warm, soapy water <b>OR</b> Paper towel and spray glass cleaner	<ul style="list-style-type: none"> <li>• Wash, rinse and dry thoroughly.</li> </ul> <p>DO NOT USE steel wool or abrasive cleaners. They may damage the finish. DO NOT SPRAY cleaner directly on panel. Apply cleaner to paper towel.</p>
<b>Exterior surfaces</b> (other than control panel)	Sponge and warm, soapy water	<ul style="list-style-type: none"> <li>• Wash, rinse and dry thoroughly.</li> </ul> <p>USE nonabrasive, plastic scrubbing pad on heavily soiled areas.</p> <ul style="list-style-type: none"> <li>• Do not use abrasive or harsh cleansers. They may damage the finish.</li> </ul> <p><b>NOTE:</b> Do not allow foods containing acids (such as vinegar, tomato or lemon juice) to remain on surface. Acids may remove the glossy finish. Also wipe up milk or egg spills when cooktop is cool.</p>
<b>Surface burner grates</b>	Warm, soapy water and a nonabrasive, plastic scrubbing pad <b>OR</b> Dishwasher	<ul style="list-style-type: none"> <li>• In dishwasher, wash with other cooking utensils.</li> <li>• Dry completely.</li> </ul> <p><b>Do not use abrasive or harsh cleansers.</b></p>
<b>Surface burners</b>	Sponge and warm, soapy water  Warm, soapy water and a nonabrasive, plastic scrubbing pad <b>OR</b> Vinegar and water solution	<ul style="list-style-type: none"> <li>• Lift up the cooktop. (See page 16.)</li> <li>• Wipe off spills immediately after burner has cooled.</li> </ul> <p><b>For cooked-on food:</b></p> <ul style="list-style-type: none"> <li>• Remove burner from manifold with Phillips screwdriver.</li> <li>• Wash with warm, soapy water and a plastic scrubbing pad or soak in vinegar and water solution.</li> <li>• Rinse and dry well.</li> <li>• If ports are clogged, clean with a straight pin.</li> </ul> <p><b>Do not enlarge or distort ports. Do not use a wooden toothpick.</b></p> <ul style="list-style-type: none"> <li>• Do not clean surface burner in dishwasher.</li> </ul>

continued on next page

## CARING FOR YOUR RANGE

PART	WHAT TO USE	HOW TO CLEAN
<b>Broiler drawer, pan and grid</b> (clean after each use)	Steel-wool pad and warm, soapy water	<ul style="list-style-type: none"> <li>• Clean after each use.</li> <li>• Wash, rinse and dry thoroughly.</li> <li>• <b>After broiler is cool</b>, wipe interior with warm, damp sponge. For heavily soiled areas, use a soapy steel-wool pad.</li> </ul>
<b>Oven racks</b>	Steel-wool pad and warm, soapy water	<ul style="list-style-type: none"> <li>• Wash, rinse and dry thoroughly.</li> </ul>
<b>Oven door glass</b> (Models SF304BSA and SF302BSA/BEA)	Paper towel and spray glass cleaner <b>OR</b> Warm, soapy water and a nonabrasive, plastic scrubbing pad	<ul style="list-style-type: none"> <li>• Make sure oven is cool.</li> <li>• Follow directions provided with the cleaner.</li> <li>• Wash, rinse and dry thoroughly.</li> </ul>
<b>Oven cavity</b>	Sponge and warm, soapy water  Soapy steel-wool pad for heavily soiled areas <b>OR</b> Commercial oven cleaner for heavily soiled areas	<ul style="list-style-type: none"> <li>• Make sure oven is cool.</li> <li>• Remove door and oven bottom for easier access. (See pages 17 and 18.)</li> <li>• Wash, rinse and dry well.</li> <li>• Remove door for easier access.</li> <li>• Rinse well with water.</li> <li>• Remove door and oven bottom for easier access.</li> <li>• Place newspaper on floor to protect floor surface.</li> <li>• Follow directions provided with the oven cleaner.</li> <li>• Rinse well with clear water.</li> <li>• Use in well-ventilated room.</li> <li>• <b>Do not allow commercial oven cleaners to contact the heat seal, thermostat or exterior surfaces of the range. Damage will occur.</b></li> </ul>

# If You Need Assistance Or Service

This section is designed to help you save the cost of a service call. Part 1 of this section outlines possible problems, their causes, and actions you can take to solve each problem. Parts 2 and 3 tell you what to do if you still need assistance or service. When calling our Consumer Assistance Center for help or calling for service, please provide a detailed description of the problem, your appliance's complete model and serial numbers and the purchase date. (See page 2.) This information will help us respond properly to your request.

## 1. Before calling for assistance ...

Performance problems often result from little things you can find and fix without tools of any kind. Please check the chart below for problems you can fix. It could save you the cost of a service call.

PROBLEM	POSSIBLE CAUSE	SOLUTION
<b>Nothing will operate</b>	<p>The power cord is not plugged into a live circuit with proper voltage.</p> <p>Range is not properly connected to gas supply.</p> <p>A household fuse has blown or a circuit breaker has tripped.</p> <p>Controls are not set correctly.</p> <p>The flow of combustion and/or ventilation air to the range is blocked.</p>	<p>Plug the power cord into a live circuit with proper voltage. (See Installation Instructions.)</p> <p>Contact an authorized Whirlpool<sup>SM</sup> service technician to reconnect range to gas supply. (See Installation Instructions.)</p> <p>Replace household fuse or reset circuit breaker.</p> <p>Reset controls, if needed.</p> <p>Remove blockage to airflow to and around range.</p>
<b>The oven will not operate</b>	<p>The Oven Temperature Control is not turned to a temperature setting.</p> <p>Pilot is extinguished on standing pilot models.</p>	<p>Push in and turn the Oven Temperature Control to a temperature setting.</p> <p>Light pilot. (See "Lighting standing pilots" on page 11.)</p>
<b>Burner fails to light</b>	<p>The power cord is not plugged into a live circuit with proper voltage.</p> <p>A household fuse has blown or a circuit breaker has tripped.</p> <p>Burner ports are clogged.</p> <p>Pilot is extinguished on standing pilot models.</p>	<p>Plug the power cord into a live circuit with proper voltage. (See Installation Instructions.)</p> <p>Replace household fuse or reset circuit breaker. In case of prolonged power failure, manually light burners (see page 8).</p> <p>Clean with a straight pin (see pages 16 and 19).</p> <p>Light pilot. (See "Lighting standing pilots" on page 11.)</p>
<b>Burner flames are uneven</b>	<p>Burner ports are clogged.</p>	<p>Clean with a straight pin (see pages 16 and 19). If this fails, call an authorized Whirlpool<sup>SM</sup> service technician for service.</p>
<b>Burner flames lift off ports, are yellow, or are noisy when turned off</b>		<p>Contact an authorized Whirlpool<sup>SM</sup> service technician to check air/gas mixture.</p>

**IF YOU NEED ASSISTANCE OR SERVICE**

PROBLEM	POSSIBLE CAUSE	SOLUTION
<b>Burner makes popping noise when on</b>	Burner is wet from washing.	Let dry.
<b>Control knob(s) will not turn</b>	You are not pushing in before turning.	Push control knob(s) in before turning to a setting.
<b>Cooking results are not what you expected</b>	<p>The range is not level.</p> <p>The oven temperature seems too low or too high.</p> <p>The oven was not preheated as the recipe calls for.</p> <p>The recipe has never been tested or is not from a reliable source.</p> <p>The pans are not the type or size recommended in the recipe.</p> <p>There is not proper air circulation around pan when baking.</p> <p>Flame size does not fit the cooking utensil being used.</p> <p>When broiling, you have not completely closed the broiler drawer.</p>	<p>Level range. (See Installation Instructions.)</p> <p>Adjust the oven temperature control. (See "Adjusting the oven temperature control" on page 13.)</p> <p>Preheat oven if called for in recipe.</p> <p>Use only tested recipes from a reliable source.</p> <p>Refer to a reliable cookbook for recommended pan type and size.</p> <p>Allow 1½ to 2 inches (4-5 cm) on all sides of the pans for air circulation. There must be a minimum space of 1 inch (2.5 cm).</p> <p>Adjust flame size to fit cooking utensil.</p> <p>Completely close broiler drawer.</p>

## 2. If you need assistance ...

Call Whirlpool Consumer Assistance Center telephone number. Dial free from anywhere in the U.S.:

**1-800-253-1301**

and talk with one of our trained consultants. The consultant can instruct you in how to obtain satisfactory operation from your appliance or, if service is necessary, recommend a qualified service company in your area.

If you prefer, write to:

Mr. William Clark  
Consumer Assistance Representative  
Whirlpool Corporation  
2000 M-63  
Benton Harbor, MI 49022

Please include a daytime phone number in your correspondence.

## 3. If you need service ...



Whirlpool has a nationwide network of authorized Whirlpool<sup>SM</sup> service companies. Whirlpool service technicians are trained to

fulfill the product warranty and provide after-warranty service, anywhere in the United States. To locate the authorized Whirlpool service company in your area, call our Consumer Assistance Center telephone number (see Step 2) or look in your telephone directory Yellow Pages under:

**•APPLIANCE-HOUSEHOLD-MAJOR, SERVICE & REPAIR**

- See: Whirlpool Appliances or Authorized Whirlpool Service  
(Example: XYZ Service Co.)

**•WASHING MACHINES & DRYERS, SERVICE & REPAIR**

- See: Whirlpool Appliances or Authorized Whirlpool Service  
(Example: XYZ Service Co.)

## 4. If you need FSP<sup>®</sup> replacement parts ...

FSP is a registered trademark of Whirlpool Corporation for quality parts. Look for this symbol of quality whenever you need a replacement part for your Whirlpool appliance. FSP replacement parts will fit right and work right, because they are made to the same exacting specifications used to build every new Whirlpool appliance.

To locate FSP replacement parts in your area, refer to Step 3 above or call the Whirlpool Consumer Assistance Center number in Step 2.

## 5. If you are not satisfied with how the problem was solved ...

- Contact the Major Appliance Consumer Action Panel (MACAP). MACAP is a group of independent consumer experts that voices consumer views at the highest levels of the major appliance industry.

- Contact MACAP only when the dealer, authorized servicer and Whirlpool have failed to resolve your problem.

Major Appliance Consumer Action Panel  
20 North Wacker Drive  
Chicago, IL 60606

- MACAP will in turn inform us of your action.

# WHIRLPOOL®

## Gas Cooking Product Warranty

LENGTH OF WARRANTY	WHIRLPOOL WILL PAY FOR
<b>FULL ONE-YEAR WARRANTY</b> From Date of Purchase	FSP® replacement parts and repair labor to correct defects in materials or workmanship. Service must be provided by an authorized Whirlpool <sup>SM</sup> service company.
<b>WHIRLPOOL WILL NOT PAY FOR</b>	
<p><b>A.</b> Service calls to:</p> <ol style="list-style-type: none"> <li>1. Correct the installation of the cooking product.</li> <li>2. Instruct you how to use the cooking product.</li> <li>3. Replace house fuses or correct house wiring or plumbing.</li> <li>4. Replace owner accessible light bulbs.</li> </ol> <p><b>B.</b> Repairs when the cooking product is used in other than normal, single-family household use.</p> <p><b>C.</b> Pickup and delivery. This product is designed to be repaired in the home.</p> <p><b>D.</b> Damage to the cooking product caused by accident, misuse, fire, flood, acts of God or use of products not approved by Whirlpool.</p> <p><b>E.</b> Repairs to parts or systems caused by unauthorized modifications made to the appliance.</p>	

8-92

WHIRLPOOL CORPORATION SHALL NOT BE LIABLE FOR INCIDENTAL OR CONSEQUENTIAL DAMAGES. Some states do not allow the exclusion or limitation of incidental or consequential damages, so this limitation or exclusion may not apply to you. This warranty gives you specific legal rights, and you may also have other rights which vary from state to state.

Outside the United States, a different warranty may apply. For details, please contact your authorized Whirlpool distributor or military exchange.

If you need service, first see the "Assistance or Service" section of this book. After checking "Assistance or Service," additional help can be found by calling our Consumer Assistance Center telephone number, **1-800-253-1301**, from anywhere in the U.S.